



e-TP80

AC Power Distributor with Filtered Receptacles

New! Furutech Power Distributor

4 Filtered and 4 Non-Filtered Hyper Quality

Non-Magnetic 24k Gold-Plated Receptacles

GC-303 EMF-Absorbing Internal Coating

All Metal Parts Treated with Furutech's

Cryogenic and Demagnetizing *Alpha Process*

The e-TP80 is a sophisticated, luxuriously made power distributor that eliminates many common problems found with audio and video components caused by massively contaminated electrical power. The AC waveform becomes severely distorted by ground noise, voltage spikes and sags, high frequency power supply noise from other components in your own system, plus radiated high frequency digital noise from processors and digital interconnects. There are also distortion products at the top and bottom of the AC waveform created by switch-mode power supplies in electronic devices on the same circuit. Additionally, you're never alone; your residential AC mains supply is shared with other apartments, homes, and businesses on the same utility transformer. That's why many audio and video enthusiasts notice their systems are more enjoyable late at night or on weekends!

How can you tell you're a victim of polluted AC power? Listen and look for these symptoms: Flat, hard, grainy high frequencies, a thick and bloated midrange, fat, uncontrolled bass, and loss of air and soundstage stability. On video displays the picture resolution is less than sharp, with "ghosting", color shift, "snow", or vertical and horizontal lines. If this looks and sound familiar, you need Furutech!

Furutech's Total Attention to Detail and Build Quality

Many A/V enthusiasts go to great lengths to carefully set up major system components, but pay little attention to the source, the AC power. Furutech knows that each and every part of the chain is as important as the next, so maximum attention is lavished by Furutech on *all* aspects of AC power transfer.

The beautifully crafted special grade aluminum chassis effectively shields against another common problem, RFI (Radio Frequency Interference), and a layer of Formula GC-303 (see below) blocks EMI (Electro Magnetic Interference). Internal wiring is Furutech μ -14, 2.0 sq. mm (14 AWG) that guarantees low resistance. Furutech Hyper Quality High Performance Receptacles are "star-wired" to the IEC AC input of the e-TP80 three- separate sets of conductors for each of the four duplex receptacles. They feature 24k gold-plated phosphor bronze, non-magnetic conductors for stable, long lasting, optimized power transfer.

Formula GC-303

GC-303 is a special material that Furutech layers and bonds to the interior bottom-plate of the chassis (see illustration below). It actually absorbs EMI (Electromagnetic Interference) generated by the *internal* fittings of the unit. The e-TP80 uses no other filtering besides GC-303 so AC resistance is kept to a minimum, allowing a more resolving, powerful, dynamic, and colorful performance from your components.

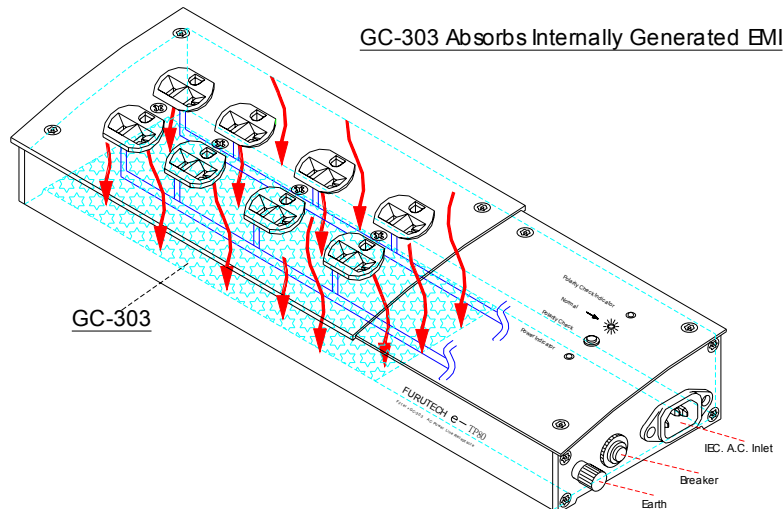

Furutech's Two-Stage Cryogenic and Demagnetization *Alpha Process*

Using cutting-edge technology and materials, Furutech developed a low-temperature two-stage process that significantly improves every facet of audio and video performance. The treatment begins during the manufacturing process with a deep, conditioning cryogenic freeze of all metal parts. Using high-end refrigerants -- liquid N₂ or He -- Furutech achieves temperatures of between -196 to -250C. The treated parts actually change their molecular structure at these extremes of temperature relieving internal stress. The molecules bond together more tightly and the overall structure becomes more stable. This improves electrical conductivity and so power and signal transfer.

Step two in the *Alpha Process* exposes these same parts to the patented Ring Demagnetization treatment. Ordinary high power magnets used for this purpose often *increase* magnetization effects; they leave some areas more magnetized than others. Just like a CD spinning over a fixed magnet; when the CD stops the area above the magnet is still exposed to the magnetic field causing audible effects. This patented process uses controlled attenuation to completely eliminate magnetization for immediately more vivid and colorful improvements. Ring Demagnetization further enhances conductivity of all treated materials. The patent holder for this treatment is Sekiguchi Machine Selling Co., Ltd. in Japan; Furutech are licensed users of the technology.

ALL metallic parts used in Furutech products go through the *Alpha Process* treatment to keep all connectors, conductors, and metal parts in a perfect stress-free, stable and highly conductive state.

The Final Result

The 2-Step Alpha Cryogenic and Demagnetizing Process works in tandem with other design-in features to create the most optimized AC power transfer possible. Furutech's total awareness and devotion to detail results in a greater sense of power, dynamics, and resolution, with cleaner, blacker backgrounds and a larger, more stable soundstage, vivid tonal colors and deeper extension at both ends of the frequency range. The e-TP80 will allow the delicacy, refinement and nuance of a performance through, along with micro- and macro-dynamics that will leave you breathlessly engaged. Displays of all types will exhibit greater, sharper resolution with less ghosting, color shift, "snow", or vertical and horizontal lines.

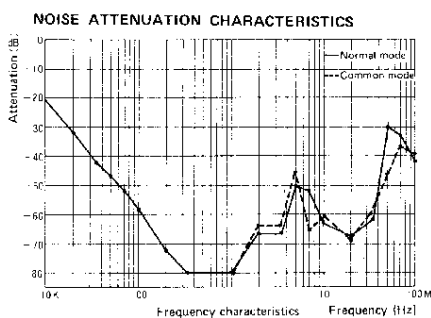
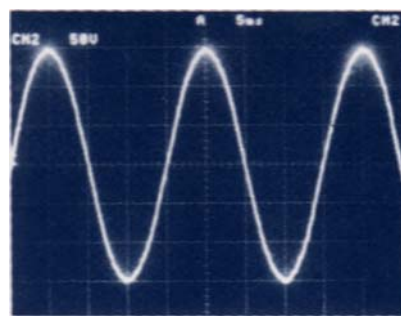
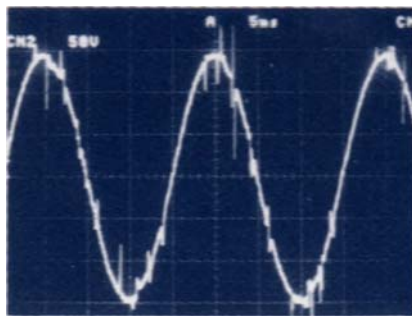

TRIP TIME COMPARISON

The typical time curve below offers a comparison of the trip times for each type of circuit protection:

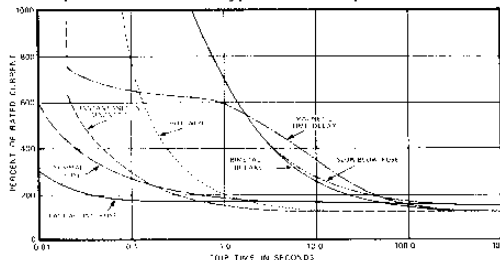

SPECIFICATION

TYPE SPECIFICATION	e- TP80	TYPE SPECIFICATION	e- TP80
VOLTAGE	AC 125V 50/60Hz	SURGE VOLTAGE	6000 V Max.
FUSE CURRENT	15 A	SURGE CURRENT	8X20 μ sec 4500 A Max.
LOADING WATT.	1875 W	SUPPRESSIVE VOLTAGE	360 V L - N (TYP)
GROUNDING OUTLET	8 Outlets	SURGE ENERGY	40J
OVERLOAD PROTECTIVE TYPE	AUTOMATIC CIRCUIT BREAKER	SURGE RESPONSE TIME	1X10 ⁻¹² THEORETICAL VALUE
INSULATION VOLT.	AC 1500V 1 MINUTE 5mA	CIRCUIT PROTECTIVE TYPE	L - N - E
LEAKAGE CURRENT	UNDER 1.0mA	MOVEMENT TEMP.	-10°C ~40°C
INSULATION RESISTANCE	300M Ω ABOVE DC 500V	PRESERVATIVE TEMP.	-20°C ~50°C
POWER INDICATOR	LED.	BODY MATERIAL	AL. ALLOY PLATE (Black Painted)
NOISE ATTENUATION	-20~92 dB (2~100MHz)	OUTWARD SIZE	400X130X60 mm
FILTER TYPE	2 CIRCUITS FILTER LC NETWORK	WEIGHT	1.72Kgs

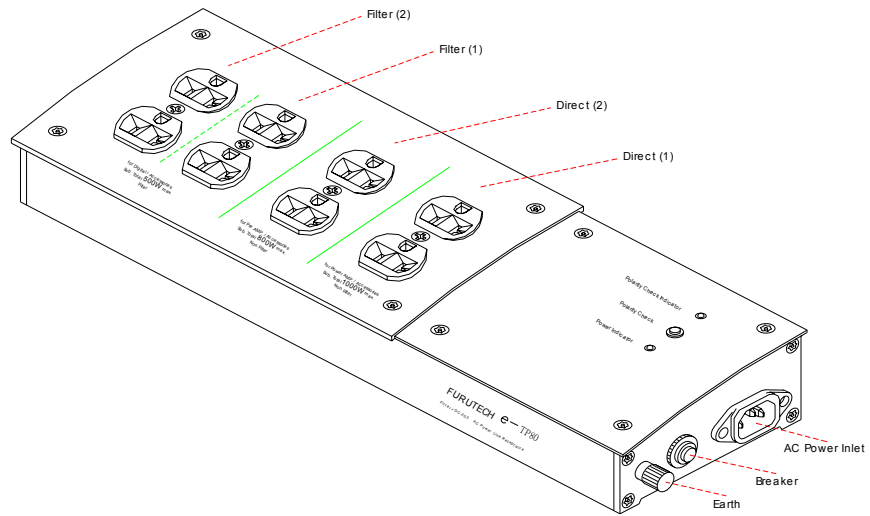

CIRCUIT PATH

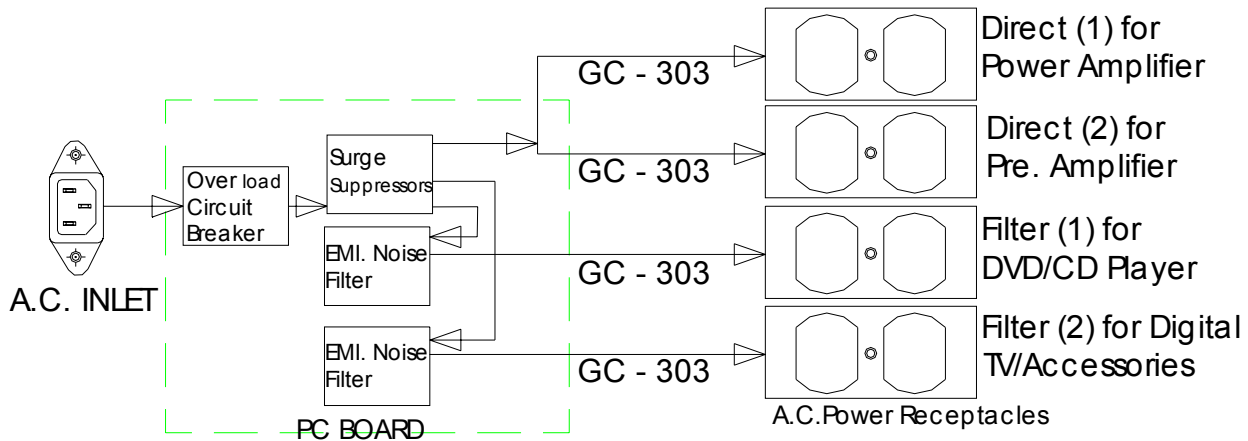

e-TP 80 AC Power Distributor with Filtered Receptacles

USER MANUAL

Thank you for purchasing the Furutech e-TP80 AC Power Distributor, optimized for 15 amp operation. The G-314Ag-18 Power Cord that is supplied is also equipped with 15A fittings. For safe and correct use of this product, please read and follow these instructions.

Voltage

Do not plug your e-TP80 into a power outlet other than that indicated for use.

Grounding and Polarization

Your e-TP80 must be used with a properly configured and grounded 15A AC wall outlet.

If you connect rooftop devices like satellite dishes, antennas, or other components make sure they are properly grounded.

Service

If for any reason your e-TP80 does not operate properly, unplug it immediately. Do not remove any chassis panels or the top cover. Consult your dealer for further information.

Caution

Do not expose your e-TP80 to extreme heat and do not connect it to heat-generating devices like space heaters. Do not operate your e-TP80 if liquid of any kind spills on or inside the chassis.

Do not operate near a window where rain comes in or near areas where plants are watered.

Maintenance

Your e-TP80 just needs an occasional light dusting. Always unplug it from the wall outlet when doing so.

Never use liquid or aerosol cleaners.

Power Surges

The e-TP80 is not a surge protector. To avoid damaging connected components when using this product, normal voltage for your location must be maintained.

PLEASE ASK YOUR DEALLER ABOUT OTHER PRODUCTS IN FURUTECH RANGE.

FURUTECH CO., LTD.

2-8-7 Higashigotanda, Shinagawa-Ku, TOKYO 141-0022, JAPAN

E-Mail : service@furutech.com